



Installation Instructions

817725

**2015-20 FORD F-150 TRUCKS*
2.7L, 3.3L, 3.5L ECO, 3.5L TIVCT & 5.0L
2/4 WD & All Wheelbases***

*Does NOT fit standard cab - 6'5 Bed

*Does NOT fit Ford Raptor

OVERVIEW:

1. Take a moment to read and understand these instructions before installing your Flowmaster performance system.

NOTE: Please inventory all parts now before continuing and if necessary, report any missing items to our tech line. This will avoid potentially stranding your vehicle until any missing replacement parts arrive.

ITM #	PART #	DESCRIPTION	QTY.
9	ST461	Stainless Tip	2
N/A	PK800	Hardware Package includes:	1
10	490HA	Ring Clamp Hanger	1
11	226HA	Rear Frame Hanger	1
12	MC250BS	2½" Stainless Band Clamp	5
13	MC300BS	3" Stainless Band Clamp	2
14	HA168	Rubber Hanger	1
15	HA226	Backing Plate	1
16	HW502	¼" Hanger Keeper	2
17	HW234	¾" x 3½" Tap Bolt	1
18	HW211	¾" x 2" Bolt	2
19	HW303	¾" Flat Washer	4
20	HW103	¾" Nut	3
21	HW309	¾" Lock Washer	3

ITM #	PART #	DESCRIPTION	QTY.
1	26532S	Inlet Pipe	1
2	26277S	Adapter Pipe	1
3	8530452-176	Muffler	1
4	86327S	Right Tailpipe	1
5	86323S	Left Front Tailpipe	1
6	86324S	Left Rear Tailpipe	1
7	86325S	Side Exit Pipe	2
8	86326S	Rear Exit Pipe	2

PREPARE VEHICLE FOR KIT INSTALLATION:

2. Raise vehicle up on a hoist or rack to working height. If you don't have access to a hoist or rack, support vehicle with jack stands.

WARNING:
Avoid serious burns! Allow your vehicle time to cool completely before touching any factory engine components.

To ease preparation and installation of your new kit:

- Apply penetrating lubricant to mounts, bolts and clamps before you remove them.
- Use stands as necessary to support parts as you detach them from your vehicle and again as you install new parts.

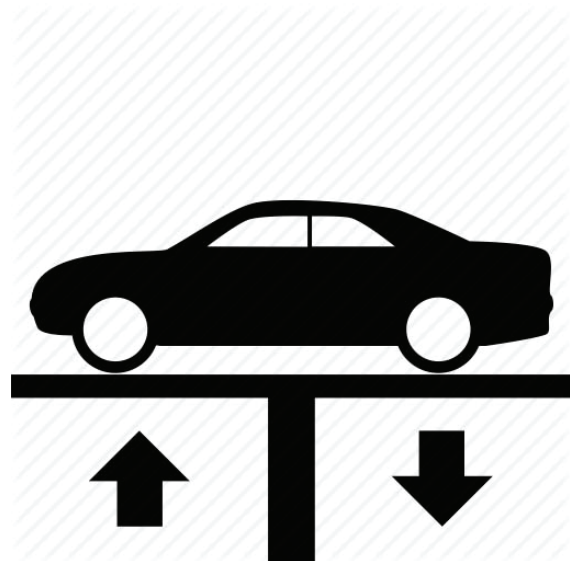

- Remove (x2) bolts at front flange connection. With help, slide exhaust system rearward to disengage hangers from isolators on vehicle, then work it forward over rear axle.

NOTE: If you are working on ground, it may be easier to cut tailpipe off at muffler rear to simplify removal.

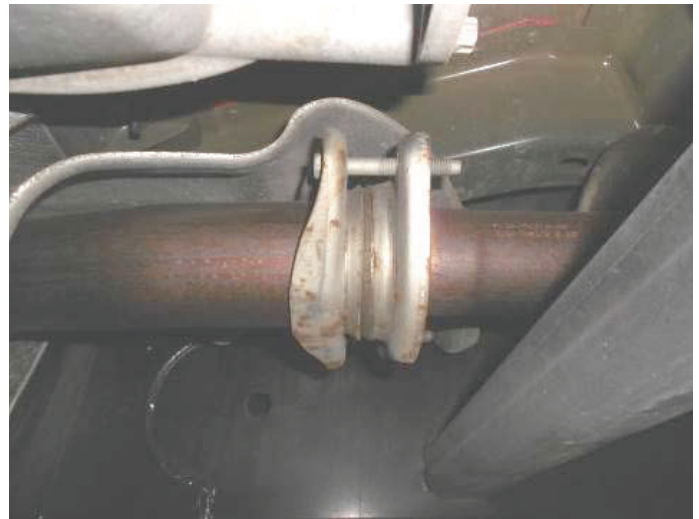

INSTALL FLOWMASTER EXHAUST SYSTEM:

- Remove nuts from stock and Flowmaster clamps, apply anti-seize compound to bolts and re-install nuts.

NOTE: The image in this step is intended for illustrative purposes only and may or may not accurately reflect components included in your kit.



- If your vehicle falls within the specifications listed below, apply the corresponding modifications or assembly combinations to this kit to ensure it will install properly.

WHEEL BASE	BODY STYLE	BED LENGTH	INLET ASSY:	MODIFICATION
141"	Regular Cab	8'	Inlet Pipe only	Trim 4" from inlet pipe
145"	SuperCrew	5'5	Inlet Pipe only	None
145"	SuperCab	6'5	Inlet Pipe only	None
157"	SuperCrew	6'5	Inlet+Extension	Trim 6" from extension pipe
163"	SuperCab	8'	Inlet+Extension	None

6. Mount **rear frame hanger (11)** to drivers' side of vehicle frame. Secure it with **tap bolt (17)**, **backing plate (15)**, **flat washer (19)**, **lock washer (21)** and **nut (20)**. Tighten fasteners then insert **rubber hanger (14)** onto end.

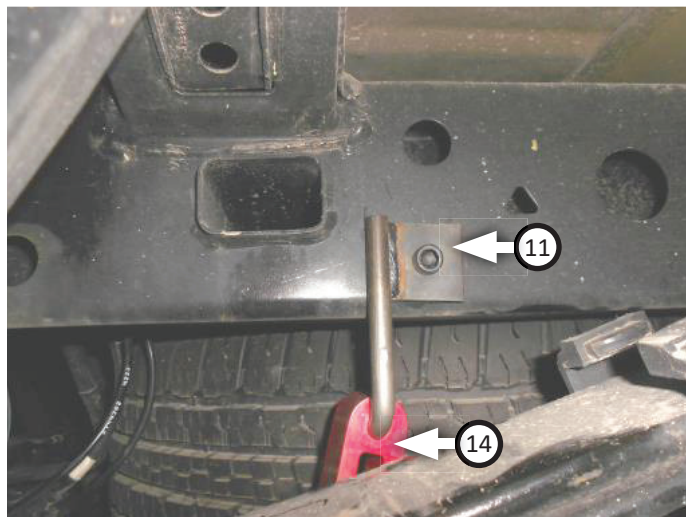

7. Place **inlet pipe (1)** onto head pipe and fasten flanges with (x2 ea.) **bolts (18)**, **flat washers (19)**, **lock washers (21)** and **nuts (20)**. Tighten them enough to hold parts.



8. Slide **ring clamp hanger (10)** over rear of the inlet pipe then insert hanger into factory isolator.
9. If applicable, place **clamp (13)** onto **adapter pipe (2)** and connect it to inlet pipe.
10. Place **clamp (13)** onto **muffler (3)** onto inlet or adapter pipe, level it and tighten clamp enough to hold parts.

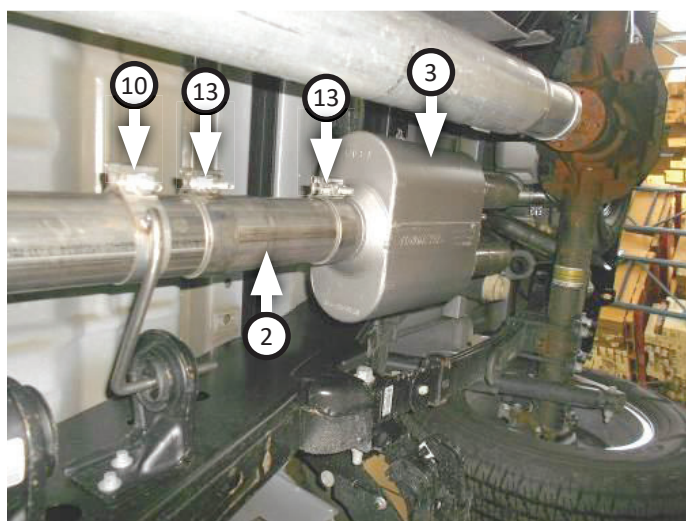

11. Place (x2) **clamps (12)** onto muffler. Route **left front (5)** and **right tailpipes (4)** over axle then connect them to muffler. Insert wire hangers into isolators then tighten clamps just enough to allow for adjustment.

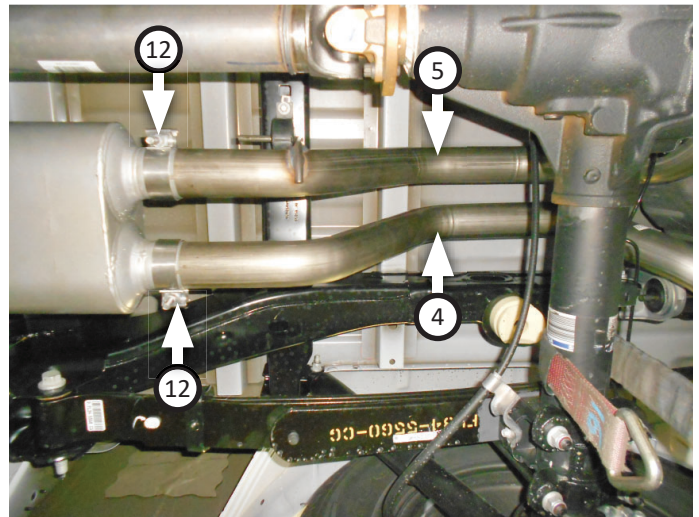

12. Place **clamp (12)** onto **left rear tailpipe (6)** then connect it to left front tailpipe. Insert wire hanger into rubber hanger then tighten clamp just enough to allow for later adjustment.

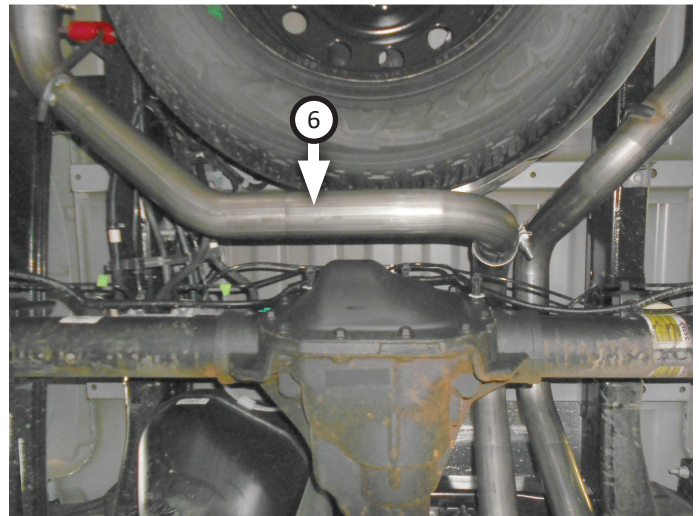

13. Place (x2 ea.) **clamps (12)** onto **side exit pipe (7)** then connect them to tailpipes and tighten clamps just enough to allow for later adjustment.

NOTE: This kit includes both side and rear exit pipes. A side exit is preferable for towing purposes, to avoid blowing fumes in or on vehicles you may be towing (eg: RV trailer, boat, etc). Otherwise, use **rear exit pipes (8)**.

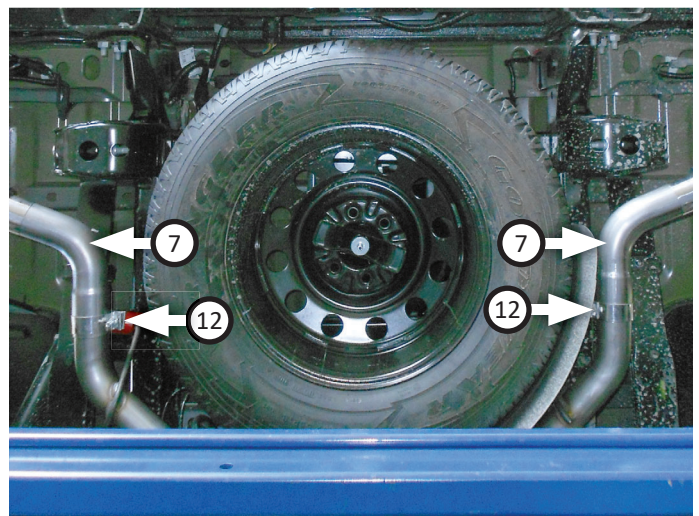

14. Place (x2) **stainless tips (9)** onto exit pipes and tighten inlets. Rotate exit pipes and tips to desired distance from body or bumper, so angle cut on tips are properly positioned.



15. Adjust exhaust components for fit; maintaining ½" clearance and compensating for suspension, travel and vibration, then tighten all clamps. Finally, fit (x2) **hanger keepers (16)** onto each sideways hanger.
16. Recommended: Secure slip-fit connections with a 1-inch tack weld then spray high-temp paint over each weld to prevent rust and premature corrosion.



Congratulations, the installation of your FLOWMASTER performance exhaust system is now complete!





Installation Diagram

817725

2015-20 FORD F-150 TRUCKS*
2.7L, 3.3L, 3.5L ECO, 3.5L TIVCT & 5.0L
2/4 WD & All Wheelbases*

*Does NOT fit standard cab - 6'5 Bed

*Does NOT fit Ford Raptor

